



AIRLESS TIPS

A small part with great importance



In this brochure you will discover **why choosing the right tip** is so essential, **how to choose the right tip** for your application and how to get the best out of your tips.

THE IMPORTANCE OF CHOOSING THE RIGHT TIP

This may only be a small part of your sprayer, but your tip is of vital importance. We will explain to you briefly and concisely why this is true.

What is the purpose of a tip?

An airless paint sprayer pushes the paint under high pressure (up to 350 bar) through the small orifice of the tip. The tip tells the pump how hard it must work in order to maintain the required pressure. The tip ensures that the paint atomises under a certain fan width and flow rate – an effect similar to placing your thumb on the end of a garden hose.

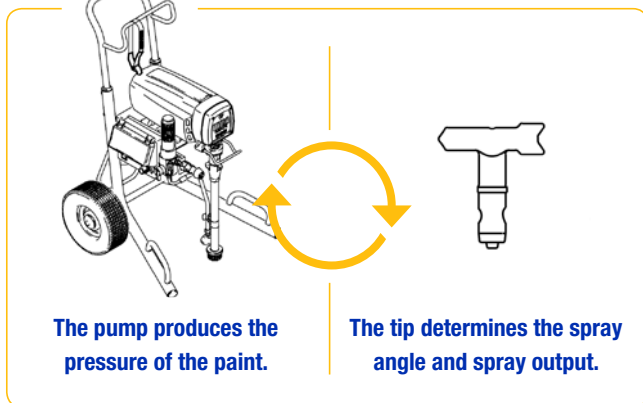

Why is the choice of a tip so important?

The correct tip ensures less overspray and therefore better control and finish. Consequently, not only will you use less paint, but you will be spending less time on the job.

The right tip:

- Increases your performance
- Improves the quality of your work
- Keeps your costs under control



Why are there so many different tips and sizes?

You can compare this to choosing the right bit for your drill. There are bits designed for wood, others are made for metal or concrete. Every bit is available in various sizes. If you use the wrong bit for the wrong surface, you won't get the result you want. The same applies to airless tips.



WHAT DOES A TIP TELL YOU? CRACKING THE CODE!

Not all tips look the same. There's a good reason for that. Discover below how various tips differ from one another.

The **colour** tells you which application you can use the tip for

There are four types of tips. Each type is used for a specific application. Each type has its own colour, so you'll be immediately able to recognise them.

- guarantees the best possible finish under lowest pressure for fine finish and wall paints
- for painting walls, suitable for paint spraying in general
- for thin plastering and less fluid materials
- for marking roads

The **first number** indicates the fan width of the tip

The first number stands for the width of the spray distribution (the fan width). It matches the angle you are spraying at. If the number is 5, then you are spraying at an angle of 50°. Multiply that number by 5 and you have a fan width if you hold the pistol 30 cm from the surface.

$$5 \times 5 = 25 \text{ fan width}$$

The last **two numbers** indicate the spray orifice of the tip

The last two numbers of the tip show the size of the spray orifice, indicated in one thousandths of an inch. The higher the number, the greater the flow with which you can spray. For example, a '517' tip enables a greater flow than a '515' tip.

'17' matches an orifice of 0.017 inch or 0.43 mm.



You have to take these three factors into consideration when choosing a tip. On pages 4 and 5, we'll go into this in greater detail.



CHOOSING THE RIGHT TIP IN 3 STEPS

Choosing the right tip is done in three steps. First, you determine which application you need the tip for (that is, which material you'll be spraying) and then the fan width and flow rate you need.

STEP 1

Which application do you need the tip for?

Tips were developed for specific applications. Materials used for a fine finish (such as staining or varnishing) require a tip with a smaller orifice. For heavier materials (such as latex), the orifice must be larger. Based on the colour of the tip, you will know immediately which tip is suitable for your application.



Interior paint jobs
and residential projects



Choose a green tip
for optimal finish under
the lowest pressure

Interior and exterior paint jobs
in homes and in commercial and
industrial projects



Choose the blue airless tip
for maximum productivity and
where overspray is not an issue

Interior and exterior paint jobs
with high production and airless
plaster applications



Choose a brown tip
for heavy-duty work

Marking parking spaces, roads
and warehouse floors, pedestrian
crossings and sport fields



Choose a yellow tip
for airless marking



For your convenience, on page 6 you will find an overview of the most common tip sizes per material.

STEP 2

How wide do you want your fan width?

The fan width is determined by the angle when spraying 30 cm from the surface. The wider the spray distribution, the faster you paint larger surfaces, but the consumption of paint is greater. With a smaller distribution, you work more slowly, but you use less paint and you have more control. Determine your fan width and divide that number by 5. That will tell you what the first number of your tip should be.

For example, if the fan width is 25 cm, then the first number of the figure must be 5 (=5x5). The number 5 matches a spray angle of 50°. By the way, if you want a fan width of 35 cm, then the first number must be a 7 (7x5=35). The angle in this case is 70°.

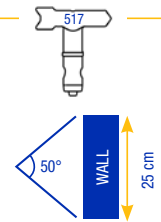

STEP 3

What is the maximum flow rate of the sprayer?

The size of the tip orifice determines the quantity of paint sprayed by the tip. The maximum flow rate of your sprayer must always be greater than that of your tip. The actual flow rate depends on the spray pressure and the type of paint used: a higher pressure results in a greater flow rate and heavier paint types reduce the flow rate.

In the table below, choose the flow rate of your tip and check whether the flow rate is appropriate for your machine. Never use a tip size greater than your machine can handle. Your machine must be able to pump at a minimal flow rate.

		FINE FINISH APPLICATIONS					PROFESSIONAL AIRLESS APPLICATIONS								HEAVY DUTY APPLICATIONS								
Inches l/min (in paint)		0.007 0.2	0.009 0.3	0.011 0.5	0.013 0.7	0.015 0.9	0.017 1.2	0.019 1.5	0.021 1.8	0.023 2.2	0.025 2.5	0.027 3.0	0.029 3.4	0.031 3.9	0.033 4.4	0.035 5	0.037 5.6	0.039 6.2	0.041 6.8	0.043 7.5	0.045 8.2	0.047 9	0.051 10.67
RANGE	MODEL																						
GX™ 21																							
GX™ FF																							
CLASSIC	390																						
ST MAX™	395																						
CLASSIC S/STMAX	495																						
STMAX/FINISHPRO	595																						
ULTRA™ MAX II	695																						
	795																						
	1095																						
MARK	IV (only with paint)																						
	V with paint																						
	V with plaster																						
	VII with paint																						
	VII with plaster																						
	X with paint*																						
	X with plaster*																						
GMAX™	3900																						
	5900 HD																						
	7900																						
DUTYMAX	200 - 300																						
BIG RIGS	2075 - 5030																						
ROOFING	1015																						

* max. tip size 0.051"

GET THE MOST OUT OF YOUR TIPS

Based on the general information from the previous pages, you can choose the tip best suited for your application. We will provide you with some additional tips & tricks for this.

Adjusting to the right tip

By experimenting with various tips, you become experienced and can easily decide which tip is the best one for your application.

TOO MUCH PAINT?

0.017" = 1.2 litres/minute

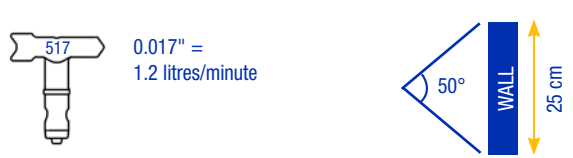

1) Use a smaller tip orifice
15 instead of 17

2) Increase the spray angle
7 instead of 5

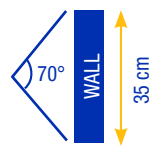

NOT ENOUGH PAINT?

0.017" = 1.17 litres/minute

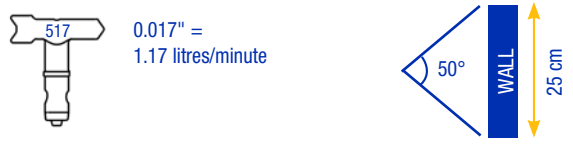

1) Use a larger tip orifice
19 instead of 17

2) Decrease the spray angle
3 instead of 5

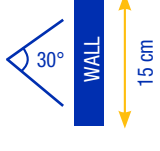

Replacing the tips on time

By remembering the comparison between tips and drilling bits, you'll also be able to understand how tip wear & tear can affect your work. Have you ever tried to drill into concrete with a worn-out bit? If you have, then you must know that it takes longer to drill a hole, that it takes more effort and that the result looks less professional.

This is also the case if you continue to spray with a worn-out tip. What is more, by using a worn-out tip, it's quite possible that you'll exceed the sprayer's maximum flow rate. At the end of the day, the worn-out tip will cost you more than a new one.

WHAT HAPPENS WHEN A TIP GETS WORN OUT?

Piston work pressure and abrasive material are the two main causes of worn-out tips.

The fan width decreases:
More spray movements are necessary
= more work

Greater tip orifice:
More paint comes out of the piston
= more costs for materials

twice as much work + 30% more paint for the same surface

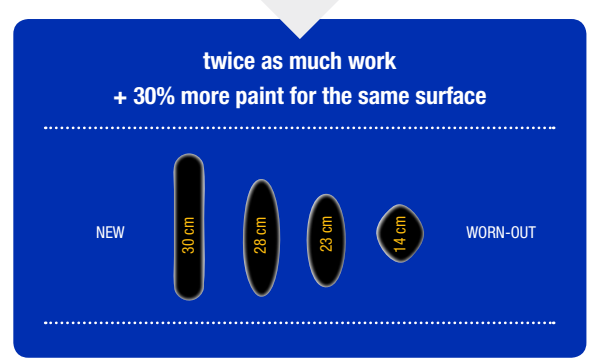

NEW 30 cm 28 cm 23 cm 14 cm WORN-OUT



Graco is always innovating, so you can tackle your tasks even more efficiently. The new RAC X™ LP* Tips are a perfect example of this. They offer the same basic advantages as the 'old' FFA or PAA RAC X™ Tips, but when using the new RAC X™ LP* Tips, you spray with 30 to 50% less pressure. Tips with lower pressure provide additional advantages.

* FFLP and LP



BETTER FINISH

The paint atomises easier without creating stripes on the side of the tip fan. You have better control of the layer thickness and it is easier to eliminate 'runners'.

LESS OVERSPRAY

The softer and more controllable spray fan ensures less overspray. This prevents you from using too much paint.

HIGHER RELIABILITY

The RAC X™ FF LP Tips allow you to spray on all materials; the result is always tip-top. In addition, these tips perform a lot better at cold temperatures.

LONGER LIFESPAN

Less pressure also means less tension on the sprayer. Your pump and tip don't get worn out so fast, and therefore you can use them longer.



**More information about our tips?
Surf to graco.com or drop by your Graco distributor**

All written and visual data contained in this document are based on the latest product information available at the time of publication. Graco reserves the right to make changes at any time without notice.

Graco is certified ISO 9001.

GRACO DISTRIBUTION BVBA Industrieterrein Oude Bunders • Slakweidestraat 31 • B-3630 Maasmechelen
Tel: +32 (89) 770 700 • Fax: +32 (89) 770 777 • <http://www.graco.com>

©2017 Graco Distribution BVBA 300666ENEU (rev.D) 02/18 Printed in Europe.
All other brand names or marks are used for identification purposes and are trademarks of their respective owners.

